

Driver LC 24W 600mA fixC R ADV

advanced round series

**Product description**

- _ Fixed output built-in LED Driver
- _ Constant current LED Driver
- _ For luminaires of protection class II
- _ Output current 600 mA
- _ For ambient temperatures up to 60 °C
- _ Nominal life-time up to 50,000 h (at ta 45 °C)
- _ 5-year guarantee

Housing properties

- _ Casing: polycarbonate, white
- _ Type of protection IP20

Functions

- _ Over voltage protection
- _ Short-circuit protection
- _ No-load protection

Typical applications

- _ For track light, wall light and other pendent application

Website

<http://www.tridonic.com/28002405>



Spotlights



Downlights



Linear



Area



Floor | Wall



Free-standing



Street



Decorative



High bay

Driver LC 24W 600mA fixC R ADV

advanced round series

The complete data sheet for this product is available in the Downloads section.

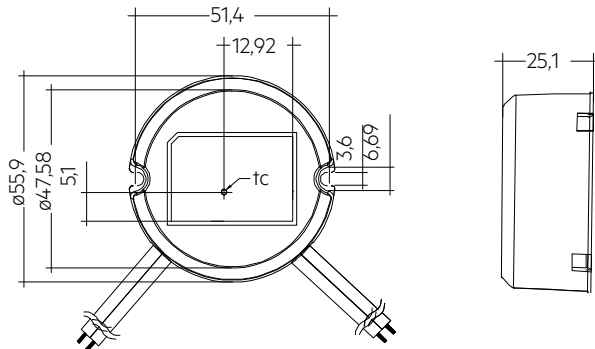

Ordering data

Type	Article number	Packaging, carton	Packaging, low volume	Weight per pc.
LC 24/600/40 fixC R ADV	28002405	100 pc(s).	1,800 pc(s).	0.1 kg

Technical data

Rated supply voltage	220 – 240 V
AC voltage range	198 – 264 V
Mains frequency	50 / 60 Hz
Typ. input current (at 230 V, 0 Hz, full load)	0.13 A
THD (at 230 V, 50 Hz, full load)	< 12 %
Output current tolerance ^①	± 5 %
Typical output LF current ripple at full load ^②	± 5 %
Starting time (at 230 V, 50 Hz, full load)	≤ 0.5 s
Turn off time (at 230 V, 50 Hz, full load)	≤ 0.5 s
Ambient temperature t_a	-20 ... +60 °C
Ambient temperature t_a (at life-time 50,000 h)	45 °C
Storage temperature t_s	-20 ... +70 °C
Mains surge capability (between L - N)	1 kV
Life-time	up to 50,000 h
Dimensions \varnothing x H	\varnothing 56 x 25 mm

Approval marks



Standards

EN 55015, EN 61000-3-2, EN 61000-3-3, EN 61347-1, EN 61347-2-13, EN 61547

Specific technical data

Type	Output current ^①	Max. input current	Typ. power consumption (at 230 V, 50 Hz, full load)	Max. input power	Output power range	λ at full load ^③	Efficiency at full load ^④	λ at min. load ^③	Efficiency at min. load ^④	Min. forward voltage	Max. forward voltage	Max. output voltage (U-OUT)	Max. peak output current at full load ^③	Max. casing temperature t_c
LC 24/600/40 fixC R ADV	600 mA	0.25 A	28 W	30 W	13 – 24 W	0.97	85 %	0.9C	80 %	21 V	40 V	52 V	630 mA	100 °C

① Output current is mean value.

② Typical value at full load, depend on load's V-I character.

③ Test result at 230 V, 50 Hz.

④ The trend between min. and full load is linear and depend on load's V-I character.